



# Data Sheet Wöhr Parklift 413

Single unit = 3 cars Suitable for condominium and office buildings.  
 Double unit = 6 cars For permanent use only!\*

\* In case of short time user  
 - only possible on upper platform  
 and only if technically adjusted,  
 ask WÖHR!  
 Or with attendant or valet parking all  
 levels are possible for short time user.

All platforms are in a horizontal  
 position to drive on.

Covered installation:  
**Load per platform max. 2000 kg**  
**(load per wheel max. 500 kg)**

☒ = only applicable if  
 garage doors are  
 to be fitted

Roller doors:  
 ☒ = 15

Sectional doors:  
 ☒ = 25 (single doors)  
 ☒ = 30 (double doors)

☒ = to be clarified with  
 door supplier

Dimensions in cm

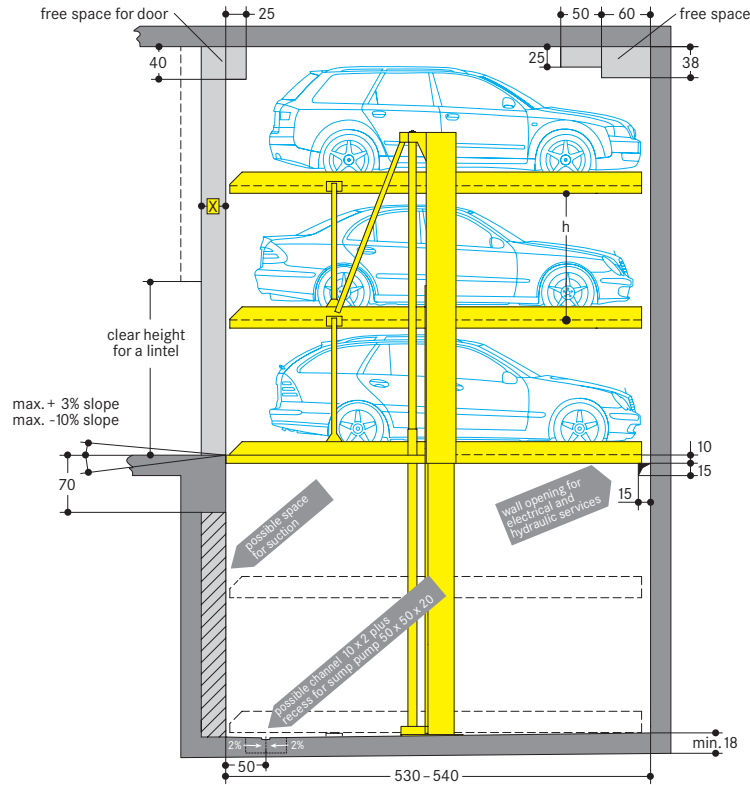

## Normal type

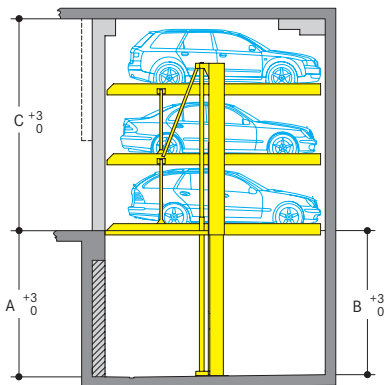

	A	B	C	h	car height*
Parklift 413-345/340:	345	340	495	160	155
Parklift 413-335/330:	335	330	480	155	150

\* upper level, entrance level and lower level for saloon and estate cars

## Comfort type

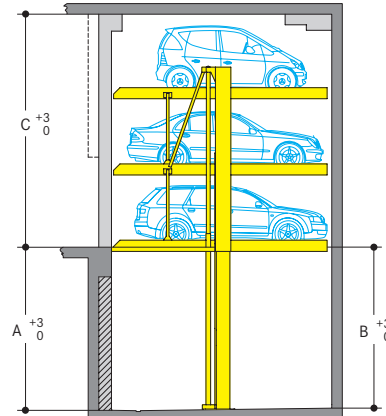

	A	B	C	h	car height*
Parklift 413-385/380:	385	380	555	180	175
Parklift 413-375/370:	375	370	540	175	170

\* upper level, entrance level and lower level for saloon and estate cars

## Clearance profile (standard saloon/estate car)

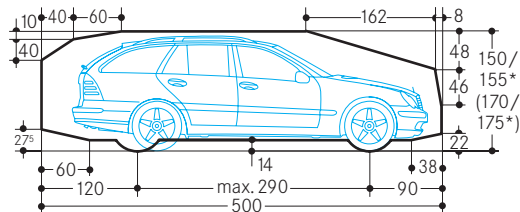
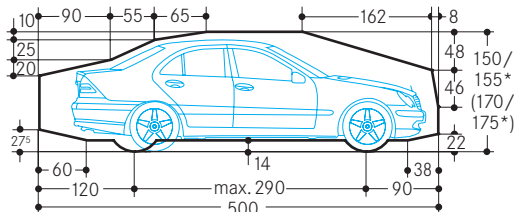

\* The total car height includes roof rail and antenna fixture and must not exceed the mentioned max. height dimension.

## Notes

1. Car width max. 190 cm (see width details page 2). In case of special platform widths narrower than 230 and 460 cm respectively, the maximum vehicle width is reduced accordingly. For cars with two outside mirrors, a minimum platform width of 250 cm or 500 cm is recommended.
2. Due to recent increases in car length dimensions, and potential future developments, a pit length of 540 cm is advisable. This offers bigger safety distances also for future cars.
3. At the edge of the pit a 10cm wide, yellow-black marking according to ISO 3864 has to be provided by the purchaser (see "statics and construction requirements" on page 3).
4. The manufacturer reserves the right to modify or alter above specifications.



## Width dimensions · Underground garages

All dimensions shown are minimum. Construction tolerances must be taken into consideration.  
All dimensions in cm.

The access to the Parklift is possible with max. 3% declination and max. 10% inclination.

If not stated differently in the offer, platform widths of 230 cm or 460 cm will be delivered. Bigger/smaller platform widths can be delivered at additional price.

### Wall to wall

Single unit (3 cars)



Space required B	gives clear platform width
270	230
280	240
290	250
300	260
310	270

Double unit (6 cars)

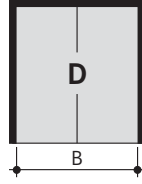

Space required B	gives clear platform width
500	460
520	480
540	500

Combinated unit (9 cars)

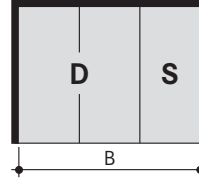

Space required B	gives clear platform width
765	460+230
795	480+240
825	500+250
835	500+260
845	500+270

Wall openings required between partitions for electrical and hydraulic conduits must be provided where applicable. Wall openings may not be closed after installation.

Minimum driveway width according to local requirements

Further width combinations as well as smaller widths are possible

### Pillars outside pit

Single unit (3 cars)

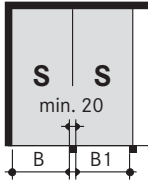

Space required wall-pillar B	pillar-pillar B1	gives clear platform width
260	245	230
270	255	240
280	265	250
290	275	260
300	285	270

Double unit (6 cars)

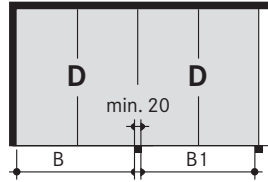

Space required wall-pillar B	pillar-pillar B1	gives clear platform width
490	475	460
510	495	480
530	515	500

Combinated unit (9 cars)

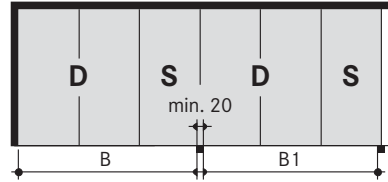

Space required wall-pillar B	pillar-pillar B1	gives clear platform width
750	740	460+230
780	770	480+240
810	800	500+250
820	810	500+260
830	820	500+270

Minimum driveway width according to local requirements

Further width combinations as well as smaller widths are possible

### Pillars inside pit

Single unit (3 cars)

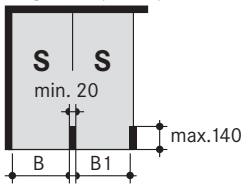

Space required wall-pillar B	pillar-pillar B1	gives clear platform width
260	245	230
270	255	240
280	265	250
290	275	260
300	285	270

Double unit (6 cars)

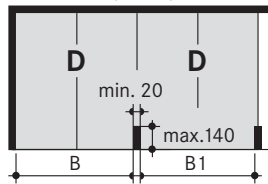

Space required wall-pillar B	pillar-pillar B1	gives clear platform width
490	475	460
510	495	480
530	515	500

Combinated unit (9 cars)

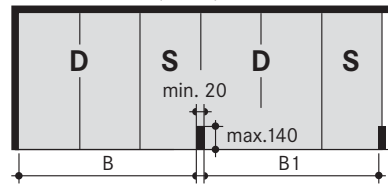

Space required wall-pillar B	pillar-pillar B1	gives clear platform width
750	740	460+230
780	770	480+240
810	800	500+250
820	810	500+260
830	820	500+270

Minimum driveway width according to local requirements

Further width combinations as well as smaller widths are possible

### Important notes

If maximum platform widths are not installed, difficulties might arise when entering or exiting the cars on the parking units. This depends on the car type, the access and the individual driving behaviour.

**Cars wider than 190 cm should be parked on platforms 270/500 cm width only.**  
**For spaces against walls, or at end of rows, we recommend that largest possible platform widths are utilized to assist turning motion.**

## Width dimensions · Garages with doors

All dimensions shown are minimum. Construction tolerances must be taken into consideration.  
All dimensions in cm.

The access to the Parklift is possible with max. 3% declination and max. 10% inclination.

If not stated differently in the offer, platform widths of 230 cm or 460 cm will be delivered. Bigger/smaller platform widths can be delivered at additional price.

### Single garages (3 cars)

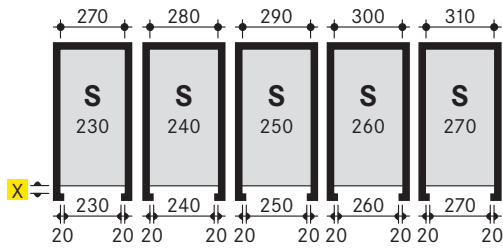

### Double garages (6 cars)

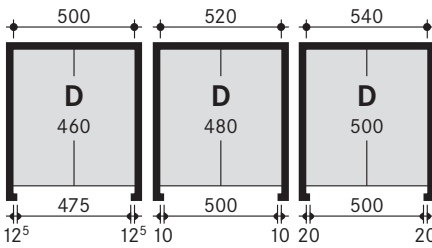

x = for doors. See page 1

Wall openings required between partitions for electrical and hydraulic conduits must be provided where applicable. Wall openings may not be closed after installation.

Minimum driveway width according to local requirements

### Serial garages with single doors (3 cars)

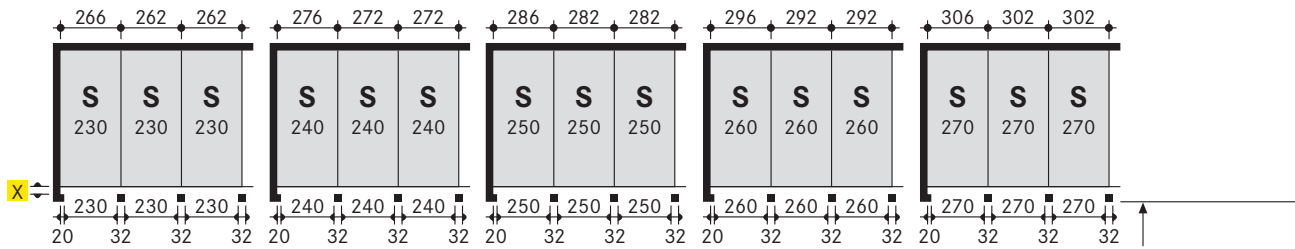

Minimum driveway width according to local requirements

### Serial garages with double doors (6 cars)

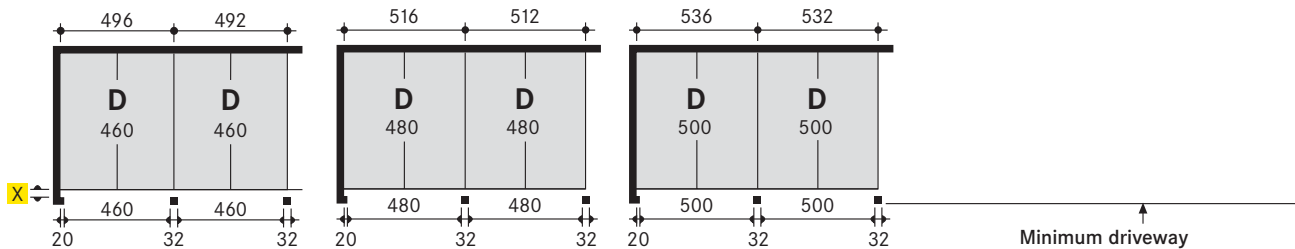

Minimum driveway width according to local requirements

## Statics and construction requirements

### Single unit

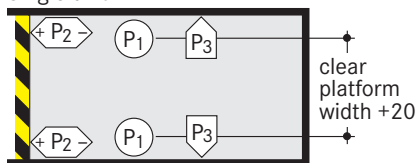

P1 = +60 kN \*  
P2 = +9 kN  
-3 kN  
P3 = +3 kN

Marking according to ISO 3864

### Double unit

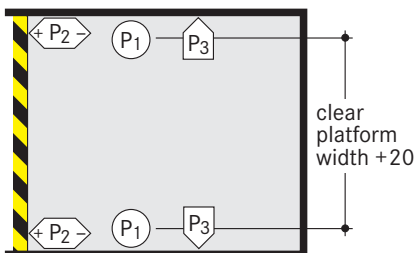

P1 = +100 kN \*  
P2 = +12 kN  
-6 kN  
P3 = +3 kN

\*all static loadings include the weight of the car

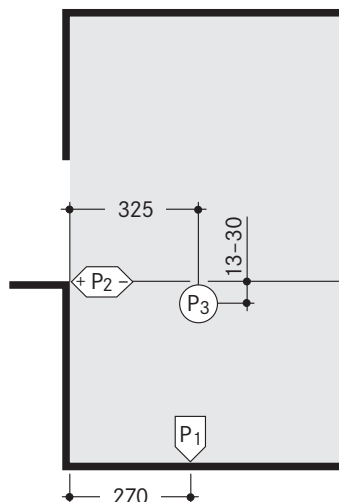

Bearing loads are transmitted to the pit floor by base plates of approximately 700cm<sup>2</sup>, fixed by heavy duty anchor bolts to a depth of approximately 10-12 cm. Base plate thickness min. 18 cm. Concrete quality according to the static requirements of the building, but for the dowel fastening we require a concrete quality of min. C20/25. When fixing to waterproof concrete floors chemical anchors are employed (to be advised by Wöhr).

The walls of the pit must be formed of concrete and must be perfectly flat and vertical without any protrusions.

The specified lengths to the support points are mean values. Please contact us for exact positions for any variations on the standard units.

## Hydraulic power pack

The location of the hydraulic power pack is determined according to your plan - space requirements are as follows:

Dimensions are in cm	1 single unit or 1 double unit	2-5 single units or 2-3 double units
Length =	100	200
Height =	140	140
Depth =	30	30

## Electrical datas

Item	Performance	Quantity	Designation	Position	Frequency
1	by customer	1 unit	electric meter	in the feed cable	
2	by customer	1 unit	fuse or automatic circuit breaker 3 x 25 A slow blow acc. to DIN VDE 0100 p. 430	in the feed cable	1 per power pack
3	by customer	as locally required	acc. to local power supply regulations 3 Ph + N + PE*	feed cable to main switch	1 per power pack
4	by customer	each 10 m	equipotential bonding safety lead-out connection	corner pit floor/ rear wall	
5	by customer	1 unit	equipotential bonding safety compliant to the DIN EN 60204 standard	from the lead-out connection to the system	1 per Parklift
6	by customer	1 unit	marked main switch, lockable to prevent unauthorized switching on	above operating device	1 per power pack
7	by customer	10 m	PVC control cable with marked strands and protective conductor 5 x 2,5 <sup>2</sup>	from main switch to hydraulic power pack	1 per power pack

Items 8-14 are included in Wöhr's scope of delivery unless otherwise specified in the offer/order.

\* DIN VDE 0100 part 410 + 430 (not under permanent load) 3PH+N+PE (three-phase current) Note: Where a door is used to close the garage, the manufacturer of the door must be consulted before the electric cable is laid.

The electrical components supplied by the manufacturer must be connected in accordance with the appropriate wiring diagram and local regulations. German VDE electrical requirements must be adhered to, in order to validate the TÜV tested circuit.

The electrical supply to the power pack(s) must be provided prior to or during installation to

enable our fitters to complete their work satisfactorily and to check the correct functioning of the units.

In compliance with the DIN EN 60204 standard provisions, all systems must be connected directly on site with an earthed equipotential bonding. The lead-out connection must be at a 10 m distance!

## Noise protection

Basis is the German DIN 4109 "Noise protection in buildings".

With the following conditions required 30 dB (A) in rooms can be provided:

- noise protection package from our accessory
- insulation figure of the construction of min.  $R'_{w} = 57$  dB
- walls which are bordering the parking systems must be done as single wall and deflection resistant with min.  $m^2 = 300$  kg/m<sup>2</sup>
- solid ceiling above the parking systems with min.  $m^2 = 400$  kg/m<sup>2</sup>

At differing constructional conditions additional sound absorbing measures are necessary.

The best results are reached by separated sole plates from the construction.

### Increased noise protection:

If increased noise protection must be provided planning has to be confirmed on a project basis by Wöhr (further building measures are required).

## Temperature

The installation is designed to operate between +5° and +40°C. Atmospheric Humidity: 50% at +40°C. If the local circumstances differ from the above please contact Wöhr.

## Drainage

We recommend the provision of a drainage channel at the front of the pit which can either incorporate a pump sump 50 x 50 x 20 cm, or a connection into the storm water sewerage

system via a petrol/oil interceptor. To prevent any possibility of contamination of the groundwater we recommend that the pit floor is coated with an oil proof paint.

## Conformity test

All our systems are checked according to EC machinery directive 2006/42/EC and EN 14010.

## Illumination

Illumination has to be considered acc. to local requirements by client.

## Installation diagram

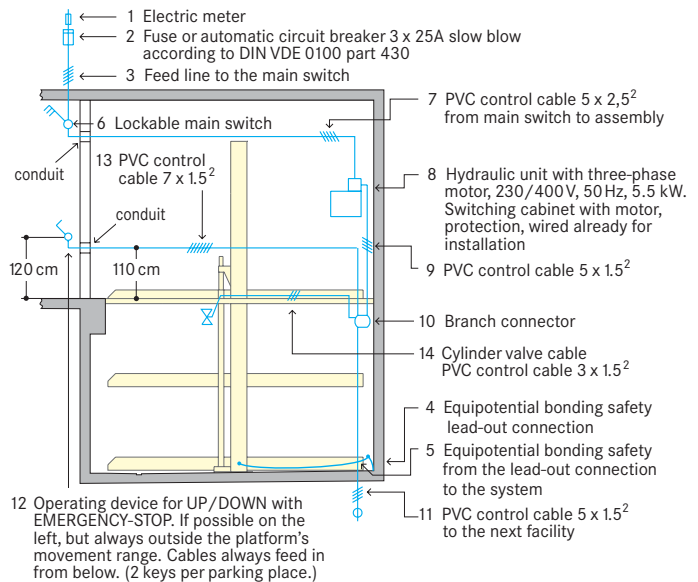

## Recesses and conduits for rotary switches with rolling and sectional gates

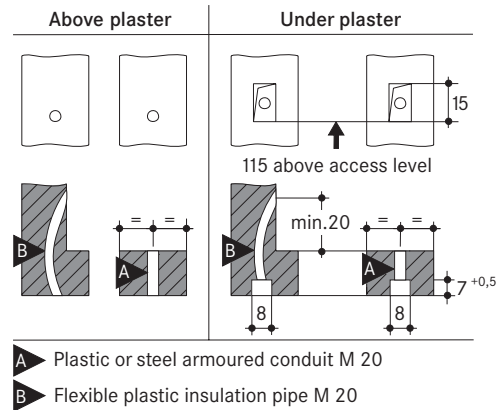

## Railings

The units need to be provided acc. EN ISO 13857 with safety railings if the gap between unit and wall exceeds 20 cm. If walkways are arranged directly to the side or behind the systems, railings have to be provided by client acc. to local requirements, height min. 200 cm - this is applicable during the construction phase too.

## Free spaces

Special drawings for free spaces to accommodate air ducts or other pipes can be requested at Wöhr Agent!

## Maintenance

Regular maintenance by qualified personnel can be provided by means of an Annual Service Contract.

## Protection against corrosion

Independent of a maintenance workings has to be carried out acc. to Wöhr Cleaning and Maintenance Instruction regularly.

Clean up galvanized parts and platforms of dirt and road salt as well as other pollution (corrosion danger)!

Pit must be always ventilated and deaired well.

## Dimensions

All dimensions shown are minimum. Construction tolerances must be taken into consideration. All dimensions in cm.